



# TrellisWare Product Catalog

## TSM Shadow Radios

- TW-135 TSM Shadow High Power Radio (HPR)
- TW-950 TSM Shadow Radio
- TW-900 TSM Shadow Radio
- TW-650 TSM Shadow Module

## TSM Ghost Radios

- TW-880 TSM Ghost Embedded Module
- TW-875 TSM Ghost Radio
- TW-870 TSM Ghost Radio

## TSM Spirit Radios

- TW-860 TSM Spirit Radio





# Table of Contents

<b>About TrellisWare</b> .....	<b>05</b>
<b>TSM Waveform</b> .....	<b>07</b>
<b>Products</b> .....	<b>08</b>
<b>TW-135 TSM Shadow HPR Radio</b> .....	<b>10</b>
<b>TW-950 TSM Shadow Radio</b> .....	<b>12</b>
<b>TW-900 TSM Shadow Radio</b> .....	<b>14</b>
<b>TW-880 TSM Ghost Embedded Module</b> .....	<b>18</b>
<b>TW-875 TSM Ghost Radio</b> .....	<b>20</b>
<b>TW-870 TSM Ghost Radio</b> .....	<b>22</b>
<b>TW-860 TSM Spirit Radio</b> .....	<b>24</b>
<b>TW-650 TSM Shadow Module</b> .....	<b>16</b>
<b>Accessories</b> .....	<b>26</b>



TrellisWare  
trellisware.com



# About TrellisWare



TrellisWare was founded by four innovators in the areas of signal processing and advanced communications. In the year 2000, the co-founders decided to pursue terrestrial applications of technology that combined foundations in signal processing innovation, with the ability to productize these ideas for the real-world in the commercial sector. We are now a worldwide leader in highly advanced algorithms, waveforms, and communications systems that range from small form factor radio products to fully integrated solutions.

Today, TrellisWare's technology is a critical component of modern tactical networks. Our TSM waveform is incorporated into a wide range of systems, including TrellisWare radios, trusted industry partner radios, and multiple government and commercial solutions. Our highly adaptable network facilitates mission critical voice and data delivery in the most severe conditions.

TrellisWare is leading innovative development programs covering a wide range of technologies that aim to meet emerging customer mission requirements. These include Audio Data Port (ADP), Data Power Port (DPP), Dynamic Spectrum Allocation (DSA), Free Space Optics (FSO), Headset Audio Port (HAP), High Frequency (HF) radio, Troposcatter, Interference Mitigation, Multi-Functional Connector (MFC), and On-The-Go (OTG) to name a few.

TrellisWare is a trademark of TrellisWare Technologies, Inc.



# TSM Release 6 Waveform

The TrellisWare TSM Waveform is the leading Mobile Ad-hoc Networking (MANET) solution to support uninterrupted communications in real dynamic environments. TrellisWare's proprietary technology, known as Barrage Relay, eliminates routing, minimizes network overhead, and provides unrivaled scalability. TSM supports 400+ nodes in a single channel, enabling a truly flat network.

The TSM waveform provides mission critical voice, situational awareness, and data sharing without depending on infrastructure or pre-deploying equipment. As a true Software Defined Radio (SDR) waveform, the TSM waveform can be implemented on many different SDRs.

The TSM waveform is also available in low SWaP SDRs that are embeddable into platforms ranging from commercial micro unmanned aerial systems to tactical radios. The result is an ecosystem that forms the most powerful network, enabling interoperability between partner platforms, sensors, and systems.

# Products

TrellisWare

Each radio in the Trellisware family of TSM-enabled products runs with the robust TSM 6 waveform. The TSM Shadow radios are available as full-featured handhelds or in vehicular configurations, while the TSM Ghost radios are small form factor and simplified. Both product lines are Software Defined Radios (SDR) that support a wide frequency range. TSM-enabled products interoperate with each other over the TSM network and are easy to integrate into larger systems for complete coverage, security, and service.





## TSM Shadow Product Line

**TW-135  
TSM Shadow HPR**

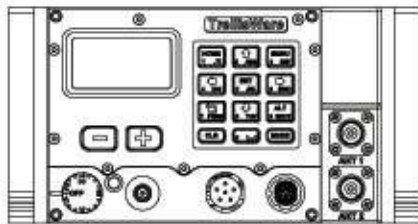

**TW-650  
TSM Shadow Module**

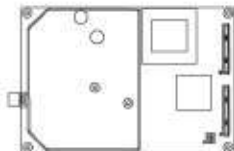

**TW-950  
TSM Shadow Radio**



**TW-900  
TSM Shadow Radio**

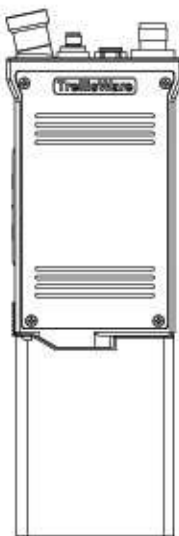

## TSM Ghost Product Line

**TW-880  
TSM Ghost  
Embedded Module**



**TW-870  
TSM Ghost Radio**



**TW-875  
TSM Ghost Radio**

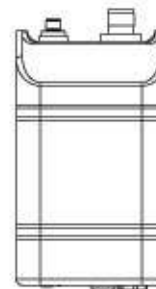

## TSM Spirit Product

**TW-860  
TSM Spirit Radio**



# TW-135 TSM SHADOW HIGH POWER RADIO (HPR)



## Highlights

- Amplified power for vehicular or aerial networks
- Up to 200+ miles with Long Range Mode enabled
- Expand TSM 6 Network range



## SPECIFICATIONS

<b>Size (R/T Only)</b>	3.40 H x 5.25 W x 7.26 D in (88.36 x 133.35 x 184.40 mm)
<b>Weight (R/T only)</b>	6.4 lbs (2.90 kg)
<b>Frequency Range</b>	LUHF: 225-450 MHz U-UHF: 698-970 MHz L/S Bands: 1250-2600 MHz
<b>Configurable Bandwidth</b>	1.2, 3.6, 10, 20, 40 MHz
<b>Transmit Power</b>	100mW, 2W, 5W, 10W, 20W
<b>Operating Temperature</b>	-20°C to +55°C (-4°F to +131°F)
<b>Environmental</b>	MIL-STD-810G
<b>Water Resistant</b>	IP67
<b>Connectors</b>	ODU Data/Audio, TNC RF, SMA GPS, 36-Pin MFC Side Connector, 6-Pin Audio
<b>IP Support</b>	IPv4, IPv6; Unicast, Multicast, Broadcast; TCP, UDP
<b>Audio Encoding</b>	AMR 5.9, MELPe, AAC Audio
<b>Video Encoding</b>	SD and HD H.264
<b>Waveform</b>	TSM Release 6

**Antennas**

- TW-1110**  
GPS Stub Antenna pg. 26
- TW-1115**  
GPS Patch Antenna pg. 26
- TW-1141**  
Magnetic Mount pg. 29
- TW-1152**  
LUHF Manpack Antenna pg. 31
- TW-1160**  
L/S Band Antenna pg. 31
- TW-1170**  
LUHF Vehicular Antenna pg. 32
- TW-1175**  
UUHF, L, and S  
Vehicular Antenna pg. 33
- TW-1180**  
Vehicular GPS Antenna pg. 33
- TW-1190**  
L/S Band Antenna pg. 33

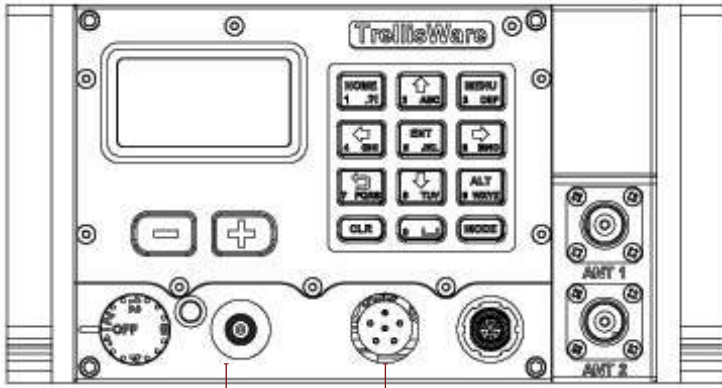

**Dongles**

- TW-1212**  
Ethernet Pigtail Dongle pg. 33
- TW-1230**  
USB Host Dongle pg. 34
- TW-1255**  
Ethernet Video Dongle pg. 34
- TW-1265**  
USB 6-Pin Dongle pg. 34
- TW-1725**  
HD Video Dongle pg. 35
- TW-1750**  
Multi-Sensor Dongle pg. 35
- TW-1760**  
Wi-Fi Dongle pg. 35

**Audio/Data Adapters**

- TW-1435**  
Audio Handset pg. 44
- TW-1605**  
V Cable 6-Pin Audio and USB pg. 44
- TW-1607**  
Audio Data Adapter, ADP to Atlantic  
Signal pg. 45
- TW-1610**  
V Cable 10-Pin Audio and USB pg. 45
- TW-1615**  
6-Pin Audio Adapter pg. 45
- TW-1617**  
Audio Adapter, ADP to  
Atlantic Signal PTT pg. 45

- TW-1618**  
ADP to Invisio PTT Cable pg. 45
- TW-1620**  
10-Pin Audio Adapter pg. 45
- TW-1650**  
ADP to Ethernet Adapter pg. 46
- TW-1665**  
Glenair Adapter pg. 46
- TW-1667**  
USB Glenair Host Cable Adapter pg. 46
- TW-1670**  
USB Type-A Adapter pg. 46

**Power/Mount Adapters**

- TW-1301**  
HPR Power Pigtail pg.36
- TW-1310**  
Battery Eliminator pg.36
- TW-1451**  
BB-2590 Battery pg.39
- TW-2220**  
Battery Canister, HPR pg. 43
- TW-2225**  
Shock Mount, HPR pg.43
- TW-2226**  
DC Adapter, HPR pg.43

# TW-950 TSM SHADOW RADIO



## Highlights

- Up to 32 Mbps and 32 talk groups
- SD and HD H.264 video encoding
- UHF, L-band, S-band in a single radio
- Transflective LCD display for controlled visibility
- 2 Talk Group-simultaneous capable



## SPECIFICATIONS

<b>Size (R/T Only)</b>	4.54 H x 2.76 W x 0.87 D in (115.31 x 70.10 x 22.09 mm)
<b>Weight (R/T only)</b>	11.3 oz (0.32 kg)
<b>Frequency Range</b>	LUHF: 225–450 MHz U-UHF: 698–970 MHz L/S-bands: 1250–2600 MHz
<b>Configurable Bandwidth</b>	1.2, 3.6, 10, 20, 40 MHz
<b>Transmit Power</b>	100mW, 250mW, 500mW, 1W, 2W
<b>Battery Life</b>	8 Hours with TW-1450 - 32 Wh Rechargeable Battery
<b>Environmental</b>	MIL-STD-810G
<b>Operating Temperature</b>	-20°C to +55°C (-4°F to +131°F)
<b>Water Resistant</b>	IP68
<b>Connectors</b>	ODU Data/Audio, TNC RF, SMA GPS, 36-Pin Side Connector
<b>Data Rate</b>	Pt. to Pt., up to 32 Mbps (1-hop)
<b>IP Support</b>	IPv4, IPv6; Unicast, Multicast, Broadcast; TCP, UDP
<b>Audio Encoding</b>	AMR 5.9, MELPe, AAC Audio
<b>Video Encoding</b>	SD and HD H.264
<b>Waveform</b>	TSM Release 6

**Audio/Data Adapters**

- TW-1605**  
V Cable 6-Pin Audio and USB pg. 44
- TW-1607**  
Audio/Data Adapter, ADP to Atlantic Signal pg. 45
- TW-1610**  
V Cable 10-Pin Audio and USB pg. 45
- TW-1615**  
6-Pin Audio Adapter pg. 45
- TW-1617**  
Audio Adapter, ADP to Atlantic Signal PTT pg. 45
- TW-1618**  
ADP to Invisio PTT Cable pg. 45
- TW-1620**  
10-Pin Audio Adapter pg. 45
- TW-1635**  
Audio Adapter pg. 46
- TW-1650**  
ADP to Ethernet Adapter pg. 46
- TW-1670**  
USB Type-A Adapter pg. 46

**Power/Mount Adapters**

- TW-1390**  
Power Adapter pg. 37
- TW-1400**  
6-18 V Power Adapter pg. 37
- TW-1401**  
Power Pigtail pg. 37
- TW-1402**  
High Capacity Battery Adapter pg. 37
- TW-1406**  
BA-5590 Power Cable pg. 38
- TW-1407**  
Tajimi Binder Power Cable pg. 38
- TW-1408**  
Power Cable pg. 38
- TW-1450**  
32 WH Rechargeable Battery pg. 38
- TW-1460**  
Single Battery Charger pg. 39
- TW-1465**  
6-Bay Battery Charger pg. 39

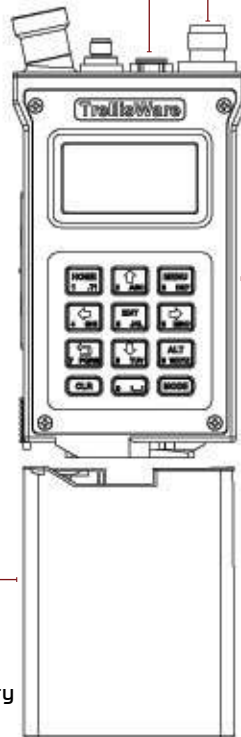

**Antennas**

- TW-1110** - GPS Stub Antenna pg. 28
- TW-1115** - GPS Patch Antenna pg. 28
- TW-1141** - Magnetic Mount pg. 29
- TW-1143** - 4dBi Dual-Band Antenna pg. 30
- TW-1144** - Narrowband Antenna pg. 30
- TW-1145** - Narrowband Antenna pg. 30
- TW-1146** - Narrowband Antenna pg. 30
- TW-1150** - LUHF Antenna pg. 30
- TW-1151** - LUHF Antenna pg. 31
- TW-1160** - Handheld U/L/S Multi-Band Antenna pg. 31
- TW-1161** - Body-Worn Antenna pg. 31
- TW-1165** - Tri-Band Antenna pg. 32
- TW-1180** - Vehicular GPS Antenna pg. 33

**Dongles**

- TW-1212** - Ethernet Pigtail Dongle pg. 33
- TW-1230** - USB Host Dongle pg. 34
- TW-1255** - Ethernet Video Dongle pg. 34
- TW-1265** - USB 6-Pin Dongle pg. 34
- TW-1725** - HD Video Dongle pg. 35
- TW-1750** - Multi-Sensor Dongle pg. 35
- TW-1760** - Wi-Fi Dongle pg. 35

# TW-900 TSM SHADOW RADIO



## Highlights

- Up to 16 Mbps and 32 talk groups
- SD and HD H.264 video encoding
- UHF, L-Band, S-Band in a single radio

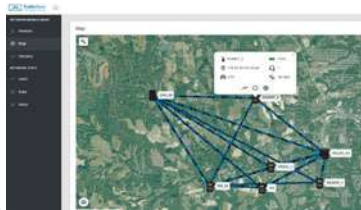

## SPECIFICATIONS

<b>Size (R/T Only)</b>	4.54 H x 2.76 W x 0.87 D in (115.31 x 70.10 x 22.09 mm)
<b>Weight (R/T only)</b>	11.3 oz (0.32 kg)
<b>Frequency Range</b>	LUHF: 225–450 MHz U-UHF: 698–970 MHz L/S-bands: 1250–2600 MHz
<b>Configurable Bandwidth</b>	1.2, 3.6, 10, 20, 40 MHz
<b>Transmit Power</b>	100mW, 250mW, 500mW, 1W, 2W
<b>Battery Life</b>	8 Hours with TW-1450 - 32 Wh Rechargeable Battery
<b>Environmental</b>	MIL-STD-810G
<b>Operating Temperature</b>	-20°C to +55°C (-4°F to +131°F)
<b>Water Resistant</b>	IP68
<b>Connectors</b>	ODU Data/Audio, TNC RF, SMA GPS, 36-Pin Side Connector
<b>Data Rate</b>	Pt. to Pt., up to 32 Mbps (1-hop)
<b>IP Support</b>	IPv4, IPv6; Unicast, Multicast, Broadcast; TCP, UDP
<b>Audio Encoding</b>	AMR 5.9, MELPe, AAC Audio
<b>Video Encoding</b>	SD and HD H.264
<b>Net Entry Time</b>	< 1 Second
<b>Waveform</b>	TSM Release 6

*Note: Product model TW-900 provides TSM Shadow capabilities without the front panel screen or keypad*

**Audio/Data Adapters**

**TW-1605**

V Cable 6-Pin Audio and USB pg. 44

**TW-1607**

Audio/Data Adapter, ADP to Atlantic Signal pg. 45

**TW-1610**

V Cable 10-Pin Audio and USB pg. 45

**TW-1615**

6-Pin Audio Adapter pg. 45

**TW-1617**

Audio Adapter, ADP To Atlantic Signal PTT pg. 45

**TW-1618**

ADP To INVISIO PTT Cable pg. 45

**TW-1620**

10-Pin Audio Adapter pg. 45

**TW-1635**

Audio Adapter pg. 46

**TW-1650**

ADP to Ethernet Adapter pg. 46

**TW-1670**

USB Type-A Adapter pg. 46

**Power/Mount Adapters**

**TW-1390**

Power Adapter pg. 37

**TW-1400**

6-18 V Power Adapter pg. 37

**TW-1401**

Power Pigtail pg. 37

**TW-1402**

High Capacity Battery Adapter pg. 37

**TW-1406**

BA-5590 Power Cable pg. 38

**TW-1407**

Tajimi Binder Power Cable pg. 38

**TW-1408**

Power Cable pg. 38

**TW-1450**

32 WH Rechargeable Battery pg. 38

**TW-1460**

Single Battery Charger pg. 39

**TW-1465**

6-Bay Battery Charger pg. 39

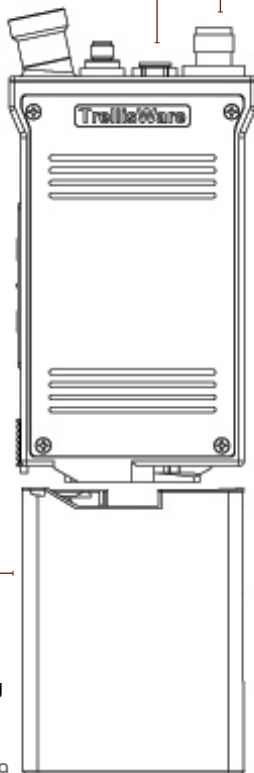

**Antennas**

**TW-1110** - GPS Stub Antenna pg. 28

**TW-1115** - GPS Patch Antenna pg. 28

**TW-1141** - Magnetic Mount pg. 29

**TW-1143** - 4dBi Dual-Band Antenna pg. 30

**TW-1144** - Narrowband Antenna pg. 30

**TW-1145** - Narrowband Antenna pg. 30

**TW-1146** - Narrowband Antenna pg. 30

**TW-1150** - LUHF Antenna pg. 30

**TW-1151** - LUHF Antenna pg. 31

**TW-1160** - Handheld U/L/S Multi-Band Antenna pg. 31

**TW-1161** - Body-Worn Antenna pg. 31

**TW-1165** - Tri-Band Antenna pg. 32

**TW-1180** - Vehicular GPS Antenna pg. 33

**Dongles**

**TW-1212** - Ethernet Pigtail Dongle pg. 31

**TW-1230** - USB Host Dongle pg. 34

**TW-1255** - Ethernet Video Dongle pg. 34

**TW-1265** - USB 6-Pin Dongle pg. 34

**TW-1725** - HD Video Dongle pg. 35

**TW-1750** - Multi-Sensor Dongle pg. 35

**TW-1760** - Wi-Fi Dongle pg. 35

# TW-650 TSM SHADOW CORE BOARD MODULE

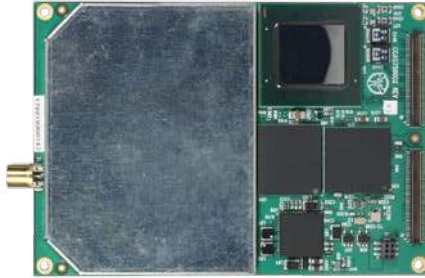

## Highlights

- Embeddable single board module
- Low Size, Weight, and Power (SWaP)
- Module for end user integration and interoperability



## SPECIFICATIONS

<b>Size</b>	2.92 H x 2.0 W x 0.108 D in (74.16 x 50.80 x 2.74 mm)
<b>Weight</b>	1.12 oz (0.03 kg) (core board with shielding)
<b>Frequency Range</b>	LUHF: 225-450 MHz U-UHF: 698-970 MHz L/S Bands: 1250-2600 MHz
<b>Configurable Bandwidth</b>	1.2, 3.6, 10, 20, 40 MHz
<b>Transmit Power</b>	0.1-2W
<b>Input Power</b>	3.0-4.0 VDC, 9.8 W max
<b>Security</b>	Built-in AES-256 COMSEC and TRANSEC
<b>Connectors</b>	Board Mount, Power and Control, PTT Audio, USB 2.0 Ports (USB-OTG, USB-H1), Serial UARTs, I2C, RF Antenna (SMP Jack), GPS
<b>Data Rate</b>	Pt. to Pt., Up to 32 Mbps (1-hop)
<b>IP Support</b>	IPv4, IPv6; Unicast, Multicast, Broadcast; TCP, UDP
<b>Audio Encoding</b>	AMR 5.9, MELPe
<b>Video Encoding</b>	H.264, HDMI, NTSC, PAL, MJPEG
<b>Waveform</b>	TSM Release 6



## TW-650 TSM Shadow Module

RF Antenna Connector

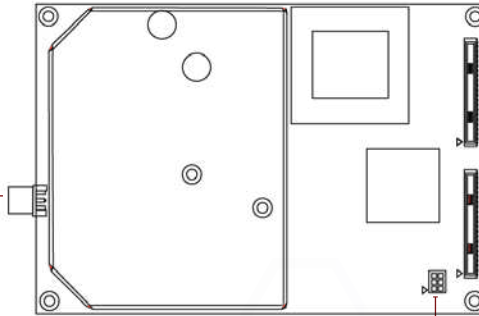

Interface I/O

Power Input Connector

# TW-880 TSM GHOST EMBEDDED MODULE

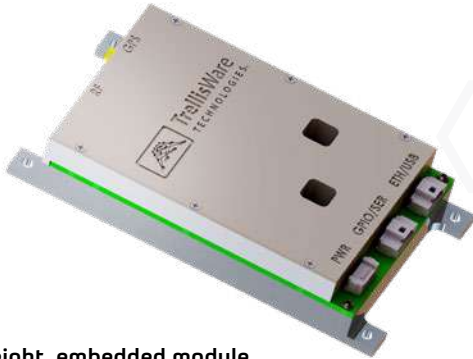

## Highlights

- Small, lightweight, embedded module
- Ethernet, serial, and USB data interfaces to meet any integration needs
- Minimal required integration effort reduces system time to market



## SPECIFICATIONS

<b>Size</b>	4.12 H x 2.30 W x 0.68 D in (104.7 x 58.4 x 17.2 mm)
<b>Weight</b>	4.64 oz (132 g)
<b>Frequency Range</b>	LUHF: 225-450 MHz U-UHF: 698-970 MHz L/S Bands: 1250-2600 MHz
<b>Configurable Bandwidth</b>	1.2, 3.6, 10, 20, 40 MHz
<b>Transmit Power</b>	100 mW, 250 mW, 500 mW, 1 W, 2 W
<b>Input Power</b>	8 to 20 VDC
<b>Environmental</b>	MIL-STD-810G Shock & Vibration
<b>Ingress Protection</b>	IP41
<b>Operating Temperature Range</b>	-20°C to +55°C (-4°F to +131°F)
<b>Interfaces</b>	USB On-the-Go, Ethernet, Control Status, Serial Data, RF SMP, GPS SMA
<b>Data Rate</b>	Pt. to Pt., up to 32 Mbps (1-hop)
<b>Waveform</b>	TSM Release 6

# COMPONENTS



Left View

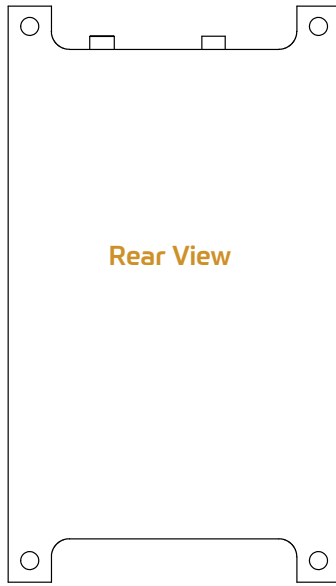

Rear View

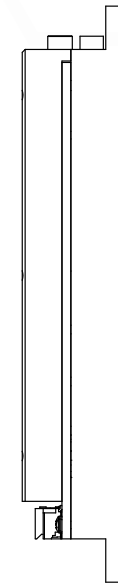
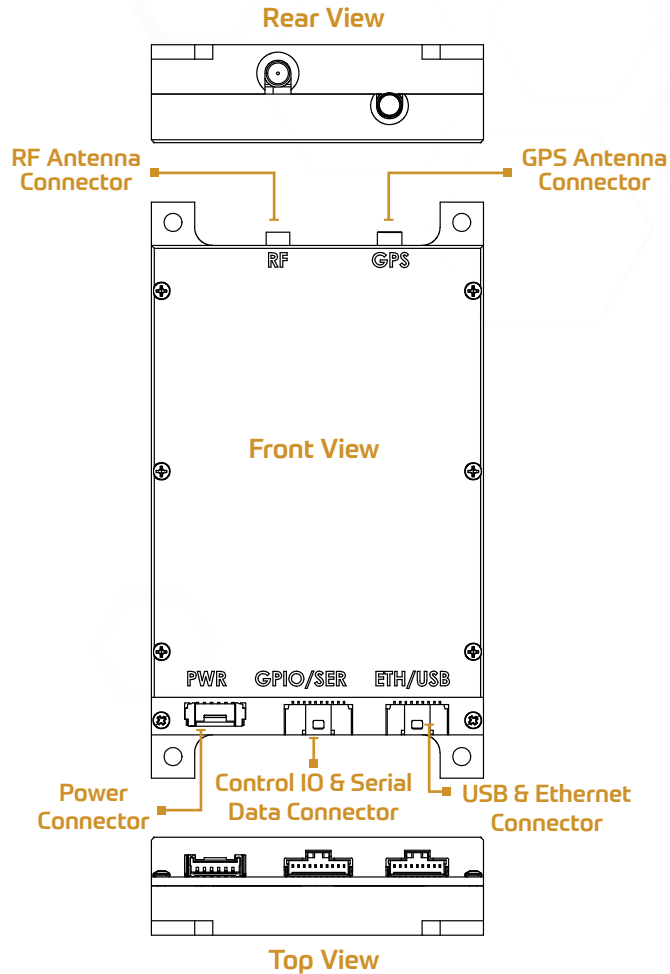

Right View

# TW-875 TSM GHOST RADIO



## Highlights

- Small Form Factor Network Relay
- Rechargeable internal battery
- Leave behind as unattended relay device



## SPECIFICATIONS

<b>Size</b>	4.06 H x 2.50 W x 1.46 D in (103.12 x 63.50 x 37.08 mm)
<b>Weight (R/T only)</b>	16 oz (0.45 kg)
<b>Frequency Range</b>	LUHF: 225-450 MHz U-UHF: 698-970 MHz L/S Bands: 1250–2600 MHz
<b>Configurable Bandwidth</b>	1.2, 3.6, 10, 20, 40 MHz
<b>Transmit Power</b>	100mW, 250mW, 500mW, 1W, 2W
<b>Input Power</b>	5 V to 20 V
<b>Environmental</b>	MIL-STD-810G
<b>Water Resistance</b>	IP68
<b>Operating Temperature</b>	-20°C to +55°C (-4°F to +131°F)
<b>Connectors</b>	USB On-the-Go, RF TNC, GPS SMA
<b>Data Rate</b>	Pt. to Pt., up to 32 Mbps (1-hop)
<b>Waveform</b>	TSM Release 6

**Antennas**

**TW-1110**

GPS Stub Antenna pg. 28

**TW-1141**

Magnetic Mount pg. 29

**TW-1143**

4dBi Dual-Band Antenna pg. 30

**TW-1150**

LUHF Antenna pg. 30

**TW-1151**

LUHF Antenna pg. 31

**TW-1160**

Handheld U/L/S Multi-Band Antenna pg. 31

**TW-1161**

Body-Worn Antenna pg. 31

**TW-1165**

Tri-Band Antenna pg. 32

**Power/Mount Adapters**

**TW-1390**

Power Cable pg. 37

**TW-1406**

BA-5590 Power Cable pg. 38

**TW-1407**

Tajimi Binder Power Cable pg. 36

**TW-1408**

Glenair Binder Power Cable pg. 38

**TW-1800**

Power Cable with Binder pg. 40

**TW-1801**

Power Pigtail pg. 40

**TW-1805**

Power Cable w/ USB Type-A Connector pg. 40

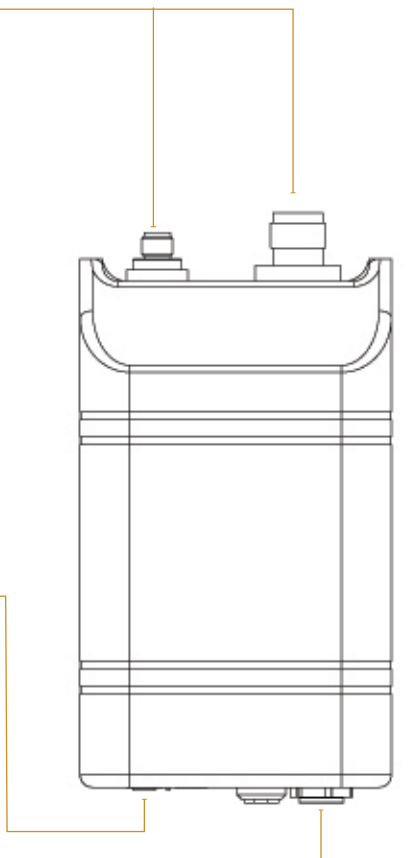

**Audio/Data Adapters**

**TW-1650**

ADP to Ethernet Adapter pg. 46

**TW-1665**

Glenair USB Adapter pg. 46

**TW-1670**

USB Type-A Adapter pg. 46

# TW-870 TSM GHOST RADIO



## Highlights

- Easy to embed, ideal for unmanned systems
- Fully capable TSM 6 data radio
- Low SWAP for integration solutions



## SPECIFICATIONS

<b>Size</b>	4.69 H x 2.46 W x 0.68 D in (119.12 x 62.48 x 17.27 mm)
<b>Weight (R/T only)</b>	8.8 oz (0.24 kg)
<b>Frequency Range</b>	LUHF: 225-450 MHz U-UHF: 698-970 MHz L/S Bands: 1250-2600 MHz
<b>Configurable Bandwidth</b>	1.2, 3.6, 10, 20, 40 MHz
<b>Transmit Power</b>	100mW, 250mW, 500mW, 1W, 2W
<b>Input Power</b>	8-20VDC
<b>Environmental</b>	MIL-STD-810G
<b>Water Resistance</b>	IP68
<b>Operating Temperature</b>	-20°C to +55°C (-4°F to +131°F)
<b>Connectors</b>	USB On-the-Go, RF SMA, GPS SMA, 4-Pin ODU Power
<b>Data Rate</b>	Pt. to Pt., up to 32 Mbps (1-hop)
<b>Waveform</b>	TSM Release 6

**Antennas**

**TW-1110**

GPS Stub Antenna pg. 28

**TW-1115**

GPS Patch Antenna pg. 26

**TW-1135**

+2 dBi Dual-Band Antenna pg. 26

**TW-1136**

Dual-Band Remote Antenna pg. 26

**TW-1137**

Dual-Band 1400/1800 Antenna pg. 29

**TW-1138**

SMA +4 dBi Antenna pg. 29

**TW-1162**

L/S Band Antenna pg. 32

**TW-1163**

Body-Worn Antenna pg. 32

**Power/Mount Adapters**

**TW-1390**

Power Cable pg. 37

**TW-1406**

BA-5590 Power Cable pg. 38

**TW-1407**

Tajimi Binder Power Cable pg. 38

**TW-1408**

Glenair Binder Power Cable pg. 38

**TW-1800**

Power Cable with Binder pg. 40

**TW-1801**

Power Pigtail pg. 40

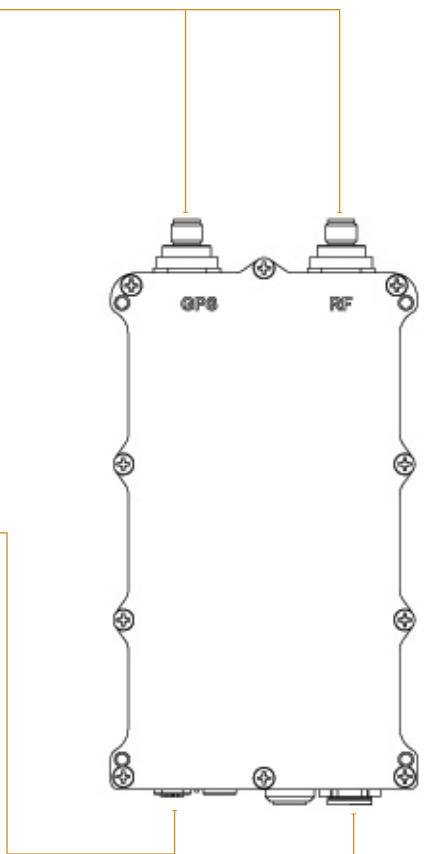

**Audio/Data Adapters**

**TW-1650**

ADP to Ethernet Adapter pg. 46

**TW-1665**

Glenair USB Adapter pg. 46

**TW-1670**

USB Type-A Adapter pg. 46

# TW-860 TSM SPIRIT RADIO



## Highlights

- Global frequency coverage
- Interoperable with all TSM-enabled radios
- World-class scalability and spectrum efficiency
- Designed for next-generation soldier systems, public safety, and first responder requirements



## SPECIFICATIONS

<b>Size</b>	4.69 H x 2.46 W x 0.68 D in (119.12 x 62.48 x 17.27 mm)
<b>Weight (R/T only)</b>	8.81oz (0.25kg)
<b>Frequency Range</b>	LUHF: 225-450 MHz U-UHF: 698-970 MHz L/S Bands: 1250-2600 MHz
<b>Configurable Bandwidth</b>	1.2, 3.6, 10, 20, 40 MHz
<b>Transmit Power</b>	100mW, 250mW, 500mW, 1W, 2W
<b>Operating Temperature</b>	-20°C to +55°C (-4°F to +131°F)
<b>Environmental</b>	MIL-STD-810H
<b>Water Resistant</b>	IP67 without USB-A cap, IP68 with USB-A cap
<b>RF Connector</b>	TNC
<b>GPS Connector</b>	SMA
<b>Audio Connector</b>	9-Pin Connector – Supports Dual Push-To-Talk (PTT) and Two Simultaneous Talkgroups
<b>Power/Data Connector</b>	12-Pin ODU Connector – Supports USB-C Power Delivery and Data
<b>Expansion Connector</b>	USB-A Connector – Supports Data, Programming, and Accessories
<b>Power Input</b>	5 V to 20 V, 3A max
<b>Data Rate</b>	Pt. to Pt., up to 32 Mbps (1-hop)
<b>Waveform</b>	TSM Release 6



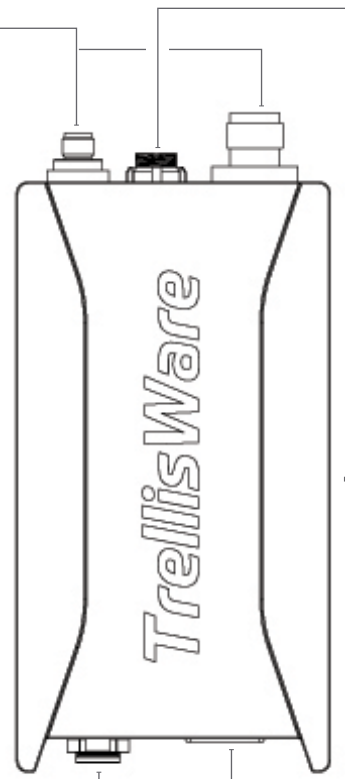

**Antennas**

- TW-1110**  
GPS Stub Antenna pg. 26
- TW-1115**  
GPS Patch Antenna pg. 26
- TW-1143**  
4dBi Dual-Band Antenna pg. 30
- TW-1144**  
Narrowband Antenna pg. 30
- TW-1145**  
Narrowband Antenna pg. 30
- TW-1146**  
Narrowband Antenna pg. 30
- TW-1150**  
LUHF Antenna pg. 30
- TW-1151**  
LUHF Antenna pg. 31
- TW-1160**  
Handheld U/L/S Multi-Band Antenna pg. 31
- TW-1161**  
Body-Worn Antenna pg. 31
- TW-1165**  
Tri-Band Antenna pg. 32

**Power/Data Adapters**

- TW-1822**  
Power Adapter, Spirit High Capacity Battery pg. 41
- TW-1828**  
Power Adapter DPP to NW Battery pg. 41
- TW-1852**  
Adapter Cable, DPP to USB-C pg. 41

**Audio Adapters**

- TW-1686**  
Audio Adapter, HAP to Falcom pg. 46
- TW-1687**  
Audio Adapter, HAP to Atlantic Signal PTT pg. 46
- TW-1688**  
Audio Adapter, HAP to Invisio PTT pg. 46

**Miscellaneous Gear**

- TW-1521**  
MOLLE Clip pg. 41

**Data Adapters**

- TW-2300**  
USB-A WiFi Adapter pg. 48
- TW-2301**  
USB-A Ethernet Adapter pg. 48
- TW-1853**  
DPP to USB-C Power and USB-A Data pg. 41
- TW-1854**  
Cable Adapter DPP to NWPAN pg. 41





# Accessories



The background features several light gray hexagonal outlines of varying sizes scattered across the page. A thin orange horizontal line is positioned below the title, ending in a small orange hexagonal icon.





Customize TSM radios to meet the needs of the network and mission with hardware accessories.







## TSM Accessories





Accessory	Catalog Number/Name	Description	Specifications	Compatible Radio
<b>Antennas</b>				
	<b>TW-1110 GPS Stub Antenna</b>	<ul style="list-style-type: none"> <li>GPS Stub antenna with a low profile immersion sealed design for GPS reception in disadvantaged areas</li> <li>Designed for operation with an unpowered SMA port</li> </ul>	<p><b>Weight:</b> 0.5 oz</p> <p><b>Size:</b> 1.24" x 0.59"</p> <p><b>Connector:</b> SMA</p> <p><b>GPS L1 Band:</b> 1575.42 MHz</p>	<p>TW-135 TSM Shadow HPR</p> <p>TW-900/950 TSM Shadow</p> <p>TW-870/875 TSM Ghost</p> <p>TW-860 TSM Spirit</p>
	<b>TW-1115 GPS Patch Antenna</b>	<ul style="list-style-type: none"> <li>GPS Patch antenna with 10' cable and a magnetic back, allowing for remote use of a GPS receiver where the GPS signal may be stronger</li> <li>Designed for operation with a powered SMA port</li> </ul>	<p><b>Weight:</b> 2.7 oz</p> <p><b>Size:</b> 1.44" x 0.5" x 0.177"</p> <p><b>Cable Length:</b> 10'</p> <p><b>Connector:</b> SMA</p>	<p>TW-135 TSM Shadow HPR</p> <p>TW-900/950 TSM Shadow</p> <p>TW-870/875 TSM Ghost</p> <p>TW-860 TSM Spirit</p>
	<b>TW-1135 +2 dBi Dual-Band Antenna</b>	<ul style="list-style-type: none"> <li>Includes a +2 dBi gain and is terminated in SMA</li> <li>Gooseneck base can bend up to 90°</li> </ul>	<p><b>Weight:</b> 1 oz</p> <p><b>Size:</b> 8.5" x 1.13" x 0.5"</p> <p><b>Connector:</b> SMA</p> <p><b>Band:</b> 1755 - 1815 MHz, 2200 - 2270 MHz</p>	<p>TW-870 TSM Ghost</p>
	<b>TW-1136 Dual-Band Remote Antenna</b>	<ul style="list-style-type: none"> <li>Rugged and covert antenna especially designed to reduce the signature when worn remotely on the operator's body</li> <li>Operates in 1800, 2200 MHz frequency bands</li> <li>Ships with SMA cable</li> </ul>	<p><b>Weight:</b> 0.8 oz</p> <p><b>Size:</b> 5.5" x 1.13"</p> <p><b>Connector:</b> SMA</p> <p><b>Band:</b> 1755 - 1815 MHz, 2200 - 2270 MHz</p>	<p>TW-870 TSM Ghost</p>

TSM Accessories				
Accessory	Catalog Number/Name	Description	Specifications	Compatible Radio
<b>Antennas</b>				
	<b>TW-1137 Dual-Band 1400 1800 RF Antenna</b>	<ul style="list-style-type: none"> <li>Ruggedized antenna for the TW-225 CheetahNet Mini radio</li> <li>Operates in the 1400 MHz and 1800 MHz frequency bands</li> <li>Has a +2 dBi gain and is terminated in SMA</li> <li>Gooseneck base can bend up to 90°</li> </ul>	<p><b>Weight:</b> 1.25 oz</p> <p><b>Size:</b> 9" x 1.5"</p> <p><b>Connector:</b> SMA</p> <p><b>Band:</b> 1410 - 1460 MHz, 1755 - 1815 MHz</p>	TW-870 TSM Ghost
	<b>TW-1138 SMA +4 dBi Antenna</b>	<ul style="list-style-type: none"> <li>Rugged antenna operating in 1800 and 2200 MHz frequency bands</li> <li>Includes a +4 dBi gain +/- .5</li> <li>Gooseneck base can bend up to 90°</li> </ul>	<p><b>Weight:</b> 1.4 oz</p> <p><b>Size:</b> 11.25"</p> <p><b>Connector:</b> SMA</p> <p><b>Band:</b> 1755 - 1815 MHz, 2200 - 2270 MHz</p>	TW-870 TSM Ghost
	<b>TW-1141 Magnetic Mount</b>	<ul style="list-style-type: none"> <li>Magnetic antenna mount to hold antennas in a secure location</li> <li>Includes 3 meters of cable terminated with a male TNC connector</li> </ul>	<p><b>Weight:</b> 4.6 or 9.2 oz (depending on cable length)</p> <p><b>Size:</b> 3 Meters or 12'</p> <p><b>Connector:</b> TNC</p>	TW-135 TSM Shadow HPR TW-900/950 TSM Shadow TW-875 TSM Ghost TW-860 TSM Spirit





TSM Accessories				
Accessory	Catalog Number/Name	Description	Specifications	Compatible Radio
<b>Antennas</b>				
	<b>TW-1143 4dBi Dual-Band Antenna</b>	<ul style="list-style-type: none"> <li>Rugged antenna operating in 1800 and 2200 MHz frequency bands</li> <li>Includes a +4 dBi gain +/- .5</li> <li>Gooseneck base can bend up to 90°</li> </ul>	<b>Weight:</b> 1.4 oz <b>Size:</b> 12" <b>Connector:</b> TNC <b>Band:</b> 1755 - 1815 MHz, 2200 - 2270 MHz	TW-135 TSM Shadow HPR TW-900/950 TSM Shadow TW-875 TSM Ghost TW-860 TSM Spirit
	<b>TW-1144 4dBi Antenna, Lower L-band</b>	<ul style="list-style-type: none"> <li>Housed in a thick UV stable radome and constructed from corrosion-resistant material for reliability in the harshest environments, this gooseneck antenna has consistent gain across the band</li> </ul>	<b>Weight:</b> 4.5 oz <b>Size:</b> 15.90" <b>Connector:</b> TNC-N <b>Band:</b> 1250 - 1450 MHz	TW-875 TSM Ghost TW-900/950 TSM Shadow TW-860 TSM Spirit
	<b>TW-1145 4dBi Antenna, L-band</b>	<ul style="list-style-type: none"> <li>Housed in a thick UV stable radome and constructed from corrosion-resistant material for reliability in the harshest environments, this gooseneck antenna has consistent gain across the band</li> </ul>	<b>Weight:</b> 4.0 oz <b>Size:</b> 13-1/8" <b>Connector:</b> TNC-M <b>Band:</b> 1750 - 1850 MHz	TW-875 TSM Ghost TW-900/950 TSM Shadow TW-860 TSM Spirit
	<b>TW-1146 4dBi Antenna, S-band</b>	<ul style="list-style-type: none"> <li>Housed in a thick UV stable radome and constructed from corrosion-resistant material for reliability in the harshest environments, this gooseneck antenna has consistent gain across the band.</li> </ul>	<b>Weight:</b> 3.7 oz <b>Size:</b> 12" <b>Connector:</b> TNC-M <b>Band:</b> 2200 - 2350 MHz	TW-875 TSM Ghost TW-900/950 TSM Shadow TW-860 TSM Spirit
	<b>TW-1150 LUHF Antenna</b>	<ul style="list-style-type: none"> <li>Rugged antenna for UHF operations</li> <li>Operates between 225 - 450 MHz frequency bands</li> <li>TNC connector to connect to the TW-1141 Magnetic Mount</li> </ul>	<b>Weight:</b> 3 oz <b>Size:</b> 10" <b>Connector:</b> TNC <b>Band:</b> 225 - 450 MHz	TW-875 TSM Ghost TW-900/950 TSM Shadow TW-860 TSM Spirit

TSM Accessories				
Accessory	Catalog Number/Name	Description	Specifications	Compatible Radio
<b>Antennas</b>				
	<b>TW-1151 LUHF Antenna</b>	<ul style="list-style-type: none"> <li>This rugged whip antenna achieves consistent gain across the LUHF band in a compact form.</li> </ul>	<b>Weight:</b> 2 oz <b>Size:</b> 10.25" <b>Connector:</b> SMA <b>Band:</b> 225 - 450 MHz	TW-900/950 TSM Shadow TW-875 TSM Ghost TW-860 TSM Spirit
	<b>TW-1152 LUHF Manpack Antenna</b>	<ul style="list-style-type: none"> <li>UHF 225 - 450 MHz</li> <li>Dipole design</li> <li>Designed for man-portable radios</li> <li>Rugged high quality antenna with a durable construction</li> </ul>	<b>Weight:</b> 9.52 oz <b>Size:</b> 22" <b>Connector:</b> TNC Female <b>Band:</b> 225 - 450 MHz	TW-135 TSM Shadow HPR
	<b>TW-1160 Handheld U/L/S Multi-Band Antenna</b>	<ul style="list-style-type: none"> <li>Broadband dipole antenna designed for military manpack or commercial mounted applications</li> <li>Operates: 698 - 2600 MHz, U-UHF, and L/S bands</li> <li>4.5" gooseneck base bends up to 90°</li> </ul>	<b>Weight:</b> 0.29 lbs <b>Size:</b> 11.37" <b>Connector:</b> TNC	TW-135 TSM Shadow HPR TW-900/950 TSM Shadow TW-875 TSM Ghost TW-860 TSM Spirit
	<b>TW-1161 Body-Worn Antenna</b>	<ul style="list-style-type: none"> <li>Broadband dipole antenna with 36" cable, designed for body worn applications</li> <li>Operates in 698 - 2600 MHz, upper UHF, and L/S bands</li> </ul>	<b>Weight:</b> 0.29 lb <b>Size:</b> 6" <b>Connector:</b> TNC	TW-135 TSM Shadow HPR TW-900/950 TSM Shadow TW-875 TSM Ghost TW-860 TSM Spirit





## TSM Accessories





Accessory	Catalog Number/Name	Description	Specifications	Compatible Radio
<b>Antennas</b>				
	<b>TW-1162 L/S Band Antenna</b>	<ul style="list-style-type: none"> <li>Broadband dipole antenna designed for military manpack or commercial mounted applications</li> <li>Operates: 698 - 2600 MHz, U-UHF, and L/S bands</li> <li>4.5" gooseneck base bends up to 90°</li> </ul>	<p><b>Weight:</b> 0.29 lbs</p> <p><b>Size:</b> 10.5"</p> <p><b>Connector:</b> SMA</p>	TW-870 TSM Ghost
	<b>TW-1163 Body-Worn Antenna</b>	<ul style="list-style-type: none"> <li>Broadband dipole antenna with 36" cable, designed for body worn applications</li> <li>Operates in 698 - 2600 MHz, upper UHF, and L/S bands</li> </ul>	<p><b>Weight:</b> 0.29 lbs</p> <p><b>Size:</b> 6"</p> <p><b>Connector:</b> SMA</p>	TW-870 TSM Ghost
	<b>TW-1165 Tri-Band Antenna</b>	<ul style="list-style-type: none"> <li>-3.0 ~ +1.0 dBi TNC Tri-Band antenna</li> <li>Operates: 225 - 450 MHz, 1300 - 2600 MHz band</li> </ul>	<p><b>Weight:</b> 4.5 oz</p> <p><b>Size:</b> 11"</p> <p><b>Connector:</b> TNC</p>	TW-875 TSM Ghost TW-900/950 TSM Shadow TW-860 TSM Spirit
	<b>TW-1170 LUHF Vehicular Antenna</b>	<ul style="list-style-type: none"> <li>Rugged vehicular antenna for ground-based communications</li> </ul>	<p><b>Size:</b> 32"</p> <p><b>Weight:</b> 4.90 lbs</p> <p><b>Connector:</b> Type N Female</p> <p><b>Band:</b> 225 - 450 MHz</p>	TW-135 TSM Shadow HPR





TSM Accessories				
Accessory	Catalog Number/Name	Description	Specifications	Compatible Radio
<b>Antennas</b>				
	<b>TW-1175 UHF, L, and S Vehicular Antenna</b>	<ul style="list-style-type: none"> <li>Rugged vehicular antenna for ground-based communications</li> </ul>	<b>Size:</b> 28.5" <b>Weight:</b> 5.0 lbs <b>Connector:</b> Type N Female <b>Band:</b> 698-2600 MHz	TW-135 TSM Shadow HPR
	<b>TW-1180 Vehicular GPS Antenna</b>	<ul style="list-style-type: none"> <li>Rugged vehicular antenna for ground-based communications</li> </ul>	<b>Size:</b> 28.5" <b>Weight:</b> 1.15 lbs <b>Connector:</b> SMA <b>Band:</b> GPS L1 Band, 1575.42 MHz	TW-135 TSM Shadow HPR
	<b>TW-1190 Dual-Band Vehicular Antenna</b>	<ul style="list-style-type: none"> <li>Rugged vehicular antenna for ground-based communications</li> <li>Fully “oak beam”-compliant</li> <li>Has a +2 dBi gain and is terminated in TNC</li> </ul>	<b>Weight:</b> 5.0 lbs <b>Size:</b> 39" <b>Connector:</b> TNC <b>Band:</b> 1755-1815 MHz, 2200-2270 MHz	TW-135 TSM Shadow HPR TW-900/950 TSM Shadow TW-870/875 TSM Ghost TW-860 TSM Spirit
<b>Dongles</b>				
	<b>TW-1212 Ethernet Pigtail Dongle</b>	<ul style="list-style-type: none"> <li>Immersible, rugged dongle that provides 100BaseT Ethernet data connectivity</li> <li>Connects to the radio's multi-functional side connector and provides a 1 meter pigtail cable that terminates in an RJ-45 connector</li> </ul>	<b>Weight:</b> 2.4 oz <b>Cable Length:</b> 1 M 100 Mbps transfer rates Ethernet Patch Cable	TW-135 TSM Shadow HPR TW-900/950 TSM Shadow

## TSM Accessories





Accessory	Catalog Number/Name	Description	Specifications	Compatible Radio
<b>Dongles</b>				
	<b>TW-1230 USB Host Dongle</b>	<ul style="list-style-type: none"> <li>• Simultaneously charge a USB device and connect to the TSM network</li> <li>• Dongle supplies up to 500 mA to USB charging compliant devices</li> </ul>	<p><b>Weight:</b> 1.2 oz</p> <p><b>Size:</b> 2.48" x 0.90" x 0.62"</p> <p><b>Connector:</b> USB Type-A</p>	TW-135 TSM Shadow HPR TW-900/950 TSM Shadow
	<b>TW-1255 Ethernet Video Dongle</b>	<ul style="list-style-type: none"> <li>• Provides Nett Warrior Ethernet connection and BNC analog video input</li> <li>• Glenair Ethernet connector provides 500 mA @ 5 V</li> <li>• 2 M immersible with BNC cover and mating connector attached</li> </ul>	<p><b>Weight:</b> 3.4 oz</p> <p><b>Size:</b> 3.34" x 1.12" x 1.13"</p> <p><b>Connector:</b> Nett Warrior Ethernet</p>	TW-135 TSM Shadow HPR TW-900/950 TSM Shadow
	<b>TW-1265 USB 6-Pin Dongle</b>	<ul style="list-style-type: none"> <li>• Immersible pigtail dongle that provides USB 2.0 connectivity</li> <li>• 6-Pin Glenair connector compatible with rugged military equipment</li> <li>• 1 M cable connects to the radio's multi-functional side connector</li> <li>• Radio acts as host and provides 500mA charging current to compliant devices</li> </ul>	<p><b>Weight:</b> 1.9 oz</p> <p><b>Length:</b> 1 M</p> <p>USB 2.0 Compatible</p> <p><b>Connector:</b> 6-Pin USB</p>	TW-135 TSM Shadow HPR TW-900/950 TSM Shadow
	<b>TW-1712 Ethernet Pigtail Dongle</b>	<ul style="list-style-type: none"> <li>• Immersible, rugged dongle that provides 100BaseT Ethernet data connectivity</li> <li>• Connects to the radio's multi-functional side connector and provides a 1 meter pigtail cable that terminates in an RJ-45 connector</li> </ul>	<p><b>Weight:</b> 2.4 oz</p> <p><b>Cable Length:</b> 1 M</p> <p>100 Mbps transfer rates</p> <p>Ethernet Patch Cable</p>	TW-135 TSM Shadow HPR TW-900/950 TSM Shadow

TSM Accessories				
Accessory	Catalog Number/Name	Description	Specifications	Compatible Radio
<b>Dongles</b>				
	<b>TW-1725 HD Video Dongle</b>	<ul style="list-style-type: none"> <li>Provides a means to High Definition video</li> <li>Supports analog video input and all trigger functions (same as TW-1750 Multi-Sensor Dongle)</li> <li>ODU connector exposes necessary signals for analog video input and all trigger I/O functions</li> </ul>	<p><b>Weight:</b> 1.7 oz</p> <p><b>Size:</b> 3" x 0.90" x 0.79"</p> <p><b>Connectors:</b> TW-1726 breakout cable and HDMI</p>	TW-135 TSM Shadow HPR TW-900/950 TSM Shadow
	<b>TW-1726 HD Video Dongle</b>	<ul style="list-style-type: none"> <li>Intended for use with the TW-1725 HD Video Dongle</li> <li>The ODU plug on the cable mates with the ODU receptacle on the TW-1725 HD Video Dongle</li> </ul>	<p><b>Weight:</b> 0.2 lbs</p> <p><b>Size:</b> 21" Length</p>	1725 HDMI Dongle
	<b>TW-1750 Multi-Sensor Dongle</b>	<ul style="list-style-type: none"> <li>Multi-Sensor dongle that provides a 100BaseT Ethernet, sensor connections, and control ports</li> <li>Hosts two 2.5 mm Trigger In ports to connect directly to sensors, a 2.5 mm Trigger Out port, a 2.5 mm Power Out port, and BNC for analog video input</li> </ul>	<p><b>Weight:</b> 1.7 oz</p> <p><b>Size:</b> 3.69" x 0.86" x 0.88"</p>	TW-135 TSM Shadow HPR TW-900/950 TSM Shadow
	<b>TW-1760 Wi-Fi Dongle</b>	<ul style="list-style-type: none"> <li>Provides an 802.11b/g access point when installed on TW-950/900 or TW-135</li> <li>Enables a connection between the TSM network and other devices such as smart phones or PDAs</li> </ul>	<p><b>Weight:</b> 1.7 oz</p> <p><b>Size:</b> 3.40" x 0.90" x 0.8"</p>	TW-135 TSM Shadow HPR TW-900/950 TSM Shadow





## TSM Accessories





Accessory	Catalog Number/Name	Description	Specifications	Compatible Radio
<b>Power/Mount Adapters</b>				
	<b>TW-1301 HPR Power Pigtail</b>	<ul style="list-style-type: none"> <li>Screws onto the back of the TW-135 TSM Shadow HPR</li> <li>Provides flying leads for custom power integrations</li> </ul>	<p><b>Weight:</b> 3.2 oz</p> <p><b>Extension Length:</b> 3'</p>	TW-135 TSM Shadow HPR
	<b>TW-1310 Battery Eliminator</b>	<ul style="list-style-type: none"> <li>With an output of 24V at 6.3 Amps, this sealed power supply allows full operation of the TW-135 TSM Shadow HPR.</li> </ul>	<p><b>Weight:</b> 1.75 lbs</p> <p><b>Input Voltage:</b> 85 - 264VAC; 100 - 240VAC Nominal, 50-60Hz</p> <p><b>Cable Length:</b> 6'</p>	TW-135 TSM Shadow HPR





TSM Accessories				
Accessory	Catalog Number/Name	Description	Specifications	Compatible Radio
<b>Power/Mount Adapters</b>				
	<b>TW-1390 Power Adapter</b>	<ul style="list-style-type: none"> <li>Enables connection to external AC power</li> <li>Waterproof power supply with 3-prong plug</li> <li>Use with accessory TW-1400</li> </ul>	<p><b>Weight:</b> 0.75 lbs</p> <p><b>Voltage:</b> 12 V DC, 30 W max output</p> <p><b>Cable Length:</b> 77"</p>	TW-900/950 TSM Shadow TW-870/875 TSM Ghost
	<b>TW-1400 6-18 V Power Adapter</b>	<ul style="list-style-type: none"> <li>Enables connection from handheld radios to external DC power for customizable power solutions</li> <li>Compatible with TW-1390, TW-1401, and TW-1406</li> </ul>	<p><b>Weight:</b> 1.8 oz</p> <p><b>Input Voltage:</b> 6-18 V DC</p> <p><b>Cable Length:</b> 16.21"</p>	TW-900/950 TSM Shadow
	<b>TW-1401 Power Pigtail</b>	<ul style="list-style-type: none"> <li>Supplies power from a remote power source</li> <li>Designed to connect to the TW-1400 Power Adapter; leads connect to DC power sources</li> <li>May be purchased separately</li> </ul>	<p><b>Weight:</b> 2 oz</p> <p><b>Input Voltage:</b> 6-18 V DC</p> <p><b>Cable Length:</b> 2 M</p>	TW-900/950 TSM Shadow
	<b>TW-1402 High Capacity Battery Adapter</b>	<ul style="list-style-type: none"> <li>Provides interface to high capacity Thales MBITR and Harris batteries</li> <li>Includes dual bayonets for connectivity between the radio and battery</li> <li>Includes locking latches</li> </ul>	<p><b>Weight:</b> 3.4 oz</p> <p><b>Size:</b> 2.60" x 1.50" x 1.09"</p> <p><b>Input Voltage:</b> 6-18 V DC</p> <p><b>Battery Life:</b> Up to 20 hours</p>	TW-900/950 TSM Shadow

## TSM Accessories





Accessory	Catalog Number/Name	Description	Specifications	Compatible Radio
<b>Power/Mount Adapters</b>				
	<b>TW-1406 BA-5590 Power Cable</b>	<ul style="list-style-type: none"> <li>Binder to BA-5590 Adapter</li> <li>Enables connection to external power</li> <li>Use with accessory TW-1400 or TW-1800</li> </ul>	<p><b>Weight:</b> 0.20 lbs</p> <p><b>Extension Length:</b> 78.74"</p>	TW-900/950 TSM Shadow TW-870/875 TSM Ghost
	<b>TW-1407 Tajimi Binder Power Cable</b>	<ul style="list-style-type: none"> <li>Binder to Tajimi</li> <li>Enables connection to external power</li> <li>Use with accessory TW-1800</li> </ul>	<p><b>Weight:</b> 2.4 oz</p> <p><b>Input Voltage:</b> 6–18 V DC</p> <p><b>Cable Length:</b> 78.74"</p>	TW-900/950 TSM Shadow TW-870/875 TSM Ghost
	<b>TW-1408 Glenair Binder Power Cable</b>	<ul style="list-style-type: none"> <li>Binder to Glenair adapter</li> <li>Enables connection from radio to a conformal battery</li> <li>Use with accessory TW-1800</li> </ul>	<p><b>Weight:</b> 0.05 lbs</p> <p><b>Input Voltage:</b> 6–18 V DC</p> <p><b>Cable Length:</b> 10"</p>	TW-900/950 TSM Shadow TW-870/875 TSM Ghost
	<b>TW-1440 Remote Power Relay</b>	<ul style="list-style-type: none"> <li>Controls power to auxiliary devices from radio</li> <li>The relay is the connection between the auxiliary device and its power source</li> <li>Use with the Power Out port on the TW-1750 Multi-Sensor Dongle for remote power</li> </ul>	<p><b>Weight:</b> 1.4 oz</p> <p><b>Size:</b> 1.54" x 1.29" x 0.8"</p> <p><b>Input Voltage:</b> 30–220 V DC @ 60 W, 0–30 V DC @ 2 AMPS</p>	TW-900/950 TSM Shadow
	<b>TW-1450 32 Wh Rechargeable Battery</b>	<ul style="list-style-type: none"> <li>Includes bayonet connector to connect to the radio</li> <li>Connector locks into position with a latch</li> <li>Compatible with the TW-1460 Single Battery Charger and TW-1465 6-bay Battery Charger</li> </ul>	<p><b>Weight:</b> 6.6 oz</p> <p><b>Size:</b> 3.20" x 2.55" x 0.95"</p> <p><b>Battery:</b> Lithium Ion</p>	TW-900/950 TSM Shadow

TSM Accessories				
Accessory	Catalog Number/Name	Description	Specifications	Compatible Radio
<b>Power/Mount Adapters</b>				
	<b>TW-1451 BB-2590 Battery</b>	<ul style="list-style-type: none"> <li>Rugged, military tough case construction</li> <li>SmartCircuit Technology - Implements SMBus v1.1 smart battery technology</li> <li>Flexible output voltage</li> <li>State-of-Charge display</li> <li>High energy density</li> <li>Higher capacity version of UBI-2590 SMBus (UBBL13)</li> </ul>	<p><b>Weight:</b> 3.1 lbs</p> <p><b>Size:</b> 4.40" x 2.40" x 5"</p> <p><b>Battery:</b> Lithium Ion</p>	TW-135 TSM Shadow HPR
	<b>TW-1460 Single Battery Charger</b>	<ul style="list-style-type: none"> <li>Compact portable charger w/ DC power adapter for charging the TW-1450 32 Wh Rechargeable Battery</li> <li>Low profile, easy to store, and charges a battery to full charge within 4 hours</li> </ul>	<p><b>Weight:</b> 1.6 oz</p> <p><b>Size:</b> 3.50" x 1.50" x 0.82"</p>	TW-900/950 TSM Shadow
	<b>TW-1465 6-Bay Battery Charger</b>	<ul style="list-style-type: none"> <li>Designed as a desktop style battery charger for charging TW-1450 32 Wh Rechargeable Batteries</li> <li>Low profile, easy to store and operate, and charges a set of 6 batteries to full charge under 4 hours</li> <li>Includes a DC power adapter</li> </ul>	<p><b>Weight:</b> 31.6 oz</p> <p><b>Size:</b> 16" x 4.88" x 3.25"</p>	TW-900/950 TSM Shadow
	<b>TW-1491 UK Power Cord</b>	<ul style="list-style-type: none"> <li>The UK Power Cord is used to plug the charger into the wall for charging the TW-1450 32 Wh Rechargeable Battery</li> </ul>	<p><b>Length:</b> 2.5 Mt</p> <p><b>Plug Type:</b> UK BS 1363A Connector</p> <p><b>Type:</b> C13</p>	TW-400 CUB TW-900/950 TSM Shadow

TSM Accessories				
Accessory	Catalog Number/Name	Description	Specifications	Compatible Radio
<b>Power/Mount Adapters</b>				
	<b>TW-1800 Power Cable with Binder</b>	<ul style="list-style-type: none"> <li>4-Pin mates to TSM Ghost power connector</li> <li>Allows TSM Ghost radios to mate to adapters: TW-1390, TW-1406, TW-1407, TW-1408</li> </ul>	<b>Weight:</b> 1.5 oz <b>Length:</b> 12" <b>Connectors:</b> ODU and Binder	TW-870/875 TSM Ghost
	<b>TW-1801 Power Pigtail</b>	<ul style="list-style-type: none"> <li>4-Pin mates to TSM Ghost power connector</li> <li>Custom terminate cable to interface of choice</li> <li>Allows radio to be powered from lab bench supply</li> </ul>	<b>Weight:</b> 1.5 oz <b>Length:</b> 40" <b>Connector:</b> ODU	TW-870/875 TSM Ghost
	<b>TW-1805 Power Cable w/ USB A Connector</b>	<ul style="list-style-type: none"> <li>TSM Ghost power cable with USB A connector</li> <li>TSM Ghost radio can be powered by commercially available USB chargers</li> </ul>	<b>Weight:</b> 1.5 oz <b>Length:</b> 18" <b>Connectors:</b> 4-Pin ODU and USB-A	TW-875 TSM Ghost













TSM Accessories				
Accessory	Catalog Number/Name	Description	Specifications	Compatible Radio
<b>Power/Mount Adapters</b>				
	<b>TW-1822 Power Adapter, TSM Spirit High Capacity Battery</b>	<ul style="list-style-type: none"> <li>Adapter enables the use of high-capacity power sources with the TW-860 TSM Spirit radio</li> <li>Adapter has a locking latch for secure battery engagement and easy battery replacement</li> </ul>	<b>Weight:</b> 3.4 oz <b>Size:</b> 2.60"x 1.50"x 1.09"	TW-860 TSM Spirit
	<b>TW-1828 Power Adapter, DPP to NW Battery</b>	<ul style="list-style-type: none"> <li>Allows the TSM Spirit radio to operate from any Nett Warrior compliant battery such as a Conformal or Land Warrior battery</li> </ul>	<b>Weight:</b> 1.6 oz <b>Size:</b> 24"	TW-860 TSM Spirit
	<b>TW-1852 Adapter Cable, DPP to USB-C</b>	<ul style="list-style-type: none"> <li>Power the TSM Spirit radio from a USB-C power pack</li> <li>Connect power and data to a USB-C port on a hub for a soldier system</li> <li>Connect power and data to a laptop for TSM Spirit radio programmin</li> </ul>	<b>Weight:</b> 1.5 oz <b>Length:</b> 74.80" <b>Connectors:</b> ODU A10WCM-P12XMM0-0000, USB-C male plug	TW-860 TSM Spirit
	<b>TW-1853 DPP to USB-C Power and USB-A Data</b>	<ul style="list-style-type: none"> <li>Power the TSM Spirit radio from a USB-C power pack while allowing simultaneous USB data access</li> <li>USB-A Data allows commercial cabling to EUDs and laptops</li> </ul>	<b>Size:</b> 40"	TW-860 TSM Spirit
	<b>TW-1854 Cable Adapter DPP to NWPAN</b>	<ul style="list-style-type: none"> <li>Integrates the TSM Spirit radio with Nett Warrior compliant hubs, providing power to the radio and a data interface in a single cable</li> <li>Compatible with Glenair STAR-PAN hubs</li> </ul>	<b>Weight:</b> 1.6 oz <b>Size:</b> 24"	TW-860 TSM Spirit







Contact [sales@trellisware.com](mailto:sales@trellisware.com) to place an order.



TSM Accessories				
Accessory	Catalog Number/Name	Description	Specifications	Compatible Radio
<b>Power/Mount Adapters</b>				
	<b>TW-2220 Battery Canister, HPR</b>	<ul style="list-style-type: none"> <li>Rugged aluminum canister creates a manpack system when used with the TW-135 TSM Shadow High Power Radio</li> </ul>	<p><b>Weight:</b> 1.5 oz</p> <p><b>Length:</b> 3" x 6.19" x 5.20"</p> <p><b>Battery:</b> Compatible with BA-5590 and BB-2590 batteries</p> <p><b>Water Resistant:</b> IP-67</p>	TW-135 TSM Shadow HPR
	<b>TW-2225 Shock Mount, HPR</b>	<ul style="list-style-type: none"> <li>A Shock/Vibration Rack/Vehicle Mount for the TW-135 TSM Shadow HPR</li> <li>Can be used with the TW-135 radio alone or with the TW-2226 12VDC Adapter installed</li> <li>Can be installed on a SINCGARs shelf</li> </ul>	<p><b>Weight:</b> 6 lbs</p> <p><b>Length:</b> 12.54" x 6.90" x 5.43"</p>	TW-135 TSM Shadow HPR
	<b>TW-2226 DC Adapter, HPR</b>	<ul style="list-style-type: none"> <li>DC adapter for the TW-135 TSM Shadow HPR</li> <li>Eliminates extensive and expensive battery replacement</li> <li>Conserves batteries for critical missions</li> <li>Integrates with TW-2225 Shock Mount</li> </ul>	<p><b>Weight:</b> 2 lbs</p> <p><b>Length:</b> 5.48" x 5.35" x 2.86"</p>	TW-135 TSM Shadow HPR
	<b>TW-2400 Secure Wi-Fi Adapter</b>	<ul style="list-style-type: none"> <li>Wi-Fi access point that provides an L2TP/IPSec VPN over the Wi-Fi connection between your radio and EUD. Can also be operated with VPN disabled to act like a standard Wi-Fi access point.</li> </ul>	<p><b>Weight:</b> 1.5 oz</p> <p><b>Length:</b> 0.50" x 3.50" x 1.63"</p> <p><b>Water Resistant:</b> IP-68</p>	TW-135 TSM Shadow HPR TW-900/950 TSM Shadow TW-870/875 TSM Ghost
	<b>TW-2401 Programming Cable, Secure WiFi</b>	<ul style="list-style-type: none"> <li>Allows users to connect TW-2400 Secure Wi-Fi Adapter to their PC for configuration</li> </ul>	<p><b>Weight:</b> 1.2 oz</p> <p><b>Size:</b> 12"</p> <p><b>Connector:</b> 6-Pin GlenAir USB Connector to USB Type-A</p>	TW-135 TSM Shadow HPR TW-900/950 TSM Shadow TW-870/875 TSM Ghost





## TSM Accessories





Accessory	Catalog Number/Name	Description	Specifications	Compatible Radio
<b>Audio/Data Adapters</b>				
	<b>TW-1430 LEMO-to-3.5 mm 3-Wire Headset Cable</b>	<ul style="list-style-type: none"> <li>Covert solution for PTT comms with the TW-225 or TW-400 radios</li> <li>Delivers crystal clear audio with a high-gain lapel mic</li> <li>Uses a 3.5 mm audio connector to use with any standard 3.5 mm headset</li> </ul>	<p><b>Weight:</b> 1.2 oz</p> <p><b>Size:</b> 40+/-1"</p> <p><b>Connector:</b> FGN.0F.305.CLC (LEMO) 3.5 mm AUDIO JACK</p>	TW-135 TSM Shadow HPR TW-900/950 TSM Shadow
	<b>TW-1431 Single Wire Curl Headset</b>	<ul style="list-style-type: none"> <li>Covert solution for PTT comms with the TW-225, TW-400 or TW-900, TW-950 radios</li> <li>Delivers crystal clear audio with a high-gain lapel mic</li> <li>Uses a LEMO connector to use with any standard headset</li> </ul>	<p><b>Weight:</b> 0.1 oz</p> <p><b>Length:</b> 48"</p> <p><b>Connector:</b> FGN.0F.305.CLC (LEMO)</p>	TW-135 TSM Shadow HPR TW-900/950 TSM Shadow
	<b>TW-1435 Audio Handset</b>	<ul style="list-style-type: none"> <li>Single Ch, single PTT</li> </ul>	<p><b>Weight:</b> 6.1 oz</p> <p><b>Length:</b> 8.30" x 5.90" x 2.70"</p> <p><b>Connector:</b> 6-Pin</p>	TW-135 TSM Shadow HPR
	<b>TW-1605 V Cable 6-Pin Audio and USB</b>	<ul style="list-style-type: none"> <li>Connects to top of radio for audio and USB</li> <li>Other capabilities include secure Wi-Fi and programming</li> <li>No side dongles are needed</li> </ul>	<p><b>Weight:</b> 3.5 oz</p> <p><b>Length:</b> 8"</p> <p><b>Connector:</b> 6-Pin</p>	TW-135 TSM Shadow HPR TW-900/950 TSM Shadow





TSM Accessories				
Accessory	Catalog Number/Name	Description	Specifications	Compatible Radio
<b>Audio/Data Adapters</b>				
	<b>TW-1607 Audio Data Adapter, ADP to Atlantic Signal</b>	<ul style="list-style-type: none"> <li>Y cable connects to the Audio Data Port (ADP) on the TSM Shadow or TSM Shadow HPR radios</li> <li>Allows operation of the OTG USB with the Glenair connector and provides an interface to the Atlantic Signal Viper 2 PTT</li> </ul>	<b>Weight:</b> 1 oz <b>Length:</b> 30" <b>Connectors:</b> 12-Pin	TW-135 TSM Shadow HPR TW-900/950 TSM Shadow
	<b>TW-1610 V Cable 10-Pin Audio and USB</b>	<ul style="list-style-type: none"> <li>Connects to top of radio for audio and USB</li> <li>Other capabilities include secure Wi-Fi and programming</li> <li>No side dongles are needed</li> </ul>	<b>Weight:</b> 3.5 oz <b>Length:</b> 8" <b>Connectors:</b> 10-Pin	TW-135 TSM Shadow HPR TW-900/950 TSM Shadow
	<b>TW-1615 6-Pin Audio Adapter</b>	<ul style="list-style-type: none"> <li>ODU to 6-Pin audio connector</li> </ul>	<b>Weight:</b> 3.3 oz <b>Length:</b> 11" <b>Connectors:</b> 6-Pin	TW-135 TSM Shadow HPR TW-900/950 TSM Shadow
	<b>TW-1617 Audio Adapter, ADP to Atlantic Signal PTT</b>	<ul style="list-style-type: none"> <li>Audio cable for connecting TW-900/950/135 radios to an Atlantic Signal Viper Dual PTT control unit</li> </ul>	<b>Weight:</b> 1.0 oz <b>Length:</b> 11"	TW-135 TSM Shadow HPR TW-900/950 TSM Shadow
	<b>TW-1618 ADP to Invisio PTT Cable</b>	<ul style="list-style-type: none"> <li>Audio cable for connecting TW-900/950/135 radios to an Invisio V60 or V20 2PTT control unit</li> </ul>	<b>Weight:</b> 1.4 oz <b>Length:</b> 31.50"	TW-135 TSM Shadow HPR TW-900/950 TSM Shadow
	<b>TW-1620 10-Pin Audio Adapter</b>	<ul style="list-style-type: none"> <li>ODU to 10-Pin audio connector</li> </ul>	<b>Weight:</b> 3.2 oz <b>Length:</b> 11" <b>Connectors:</b> 10-Pin	TW-135 TSM Shadow HPR TW-900/950 TSM Shadow

Contact [sales@trellisware.com](mailto:sales@trellisware.com) to place an order.

## TSM Accessories

Accessory	Catalog Number/Name	Description	Specifications	Compatible Radio
<b>Audio/Data Adapters</b>				
	<b>TW-1635 Audio Adapter</b>	<ul style="list-style-type: none"> <li>• ODU 12-Pin to LEMO 5-Pin connector</li> <li>• Audio adapter allowing compatibility of audio accessories with TSM Shadow</li> </ul>	<p><b>Weight:</b> .97 oz</p> <p><b>Length:</b> 5.625"</p> <p><b>Connectors:</b> ODU and LEMO (PHN.OF.305. XLM)</p>	TW-135 TSM Shadow HPR TW-900/950 TSM Shadow
	<b>TW-1650 ADP to Ethernet Adapter</b>	<ul style="list-style-type: none"> <li>• Provides 100 BaseT Ethernet data connectivity</li> <li>• Connects to the Audio Data Port (ADP) on the radio and provides a female RJ 45 jack</li> </ul>	<p><b>Weight:</b> 2.4 oz</p> <p><b>Length:</b> 18"</p> <p><b>Connector:</b> Ethernet Adapter</p>	TW-135 TSM Shadow HPR TW-900/950 TSM Shadow TW-870/875 TSM Ghost
	<b>TW-1665 Glenair USB Adapter</b>	<ul style="list-style-type: none"> <li>• Data only cable</li> <li>• Allows operation of the OTG USB with Glenair USB connection</li> <li>• Enables use of EUD</li> </ul>	<p><b>Weight:</b> 1.6 oz</p> <p><b>Length:</b> 24"</p> <p><b>Connectors:</b> Glenair USB</p>	TW-135 TSM Shadow HPR TW-900/950 TSM Shadow TW-870/875 TSM Ghost
	<b>TW-1667 USB Glenair Host Mode Cable</b>	<ul style="list-style-type: none"> <li>• Data only cable</li> <li>• Enables use of EUD</li> <li>• Sets the radio as the USB host</li> </ul>	<p><b>Weight:</b> 3.0 oz</p> <p><b>Length:</b> 6-24"</p> <p><b>Connectors:</b> Glenair</p>	TW-135 TSM Shadow HPR TW-900/950 TSM Shadow TW-870/875 TSM Ghost
	<b>TW-1670 USB Type-A Adapter</b>	<ul style="list-style-type: none"> <li>• Connects to top of radio for USB, data, and programming</li> <li>• ODU to USB-A Connector</li> </ul>	<p><b>Weight:</b> 3.0 oz</p> <p><b>Length:</b> 10"</p> <p><b>Connectors:</b> USB-A</p>	TW-135 TSM Shadow HPR TW-900/950 TSM Shadow TW-870/875 TSM Ghost

TSM Accessories				
Accessory	Catalog Number/Name	Description	Specifications	Compatible Radio
<b>Audio/Data Adapters</b>				
	<b>TW-1685 Audio Adapter, HAP to 6-pin</b>	<ul style="list-style-type: none"> <li>This audio adapter has single talk group audio capability with a standard 6-pin audio connector</li> </ul>	<b>Weight:</b> <b>Length:</b> <b>Connectors:</b>	TW-860 TSM Spirit
	<b>TW-1686 Audio Adapter, HAP to Falcom PTT</b>	<ul style="list-style-type: none"> <li>Provide audio capability with 2 Talk Groups when used with Falcom PTT and headset</li> </ul>	<b>Weight:</b> <b>Length:</b> <b>Connectors:</b>	TTW-860 TSM Spirit
	<b>TW-1687 Audio Adapter, HAP to Atlantic Signal PTT</b>	<ul style="list-style-type: none"> <li>Provide audio capability with 2 Talk Groups when used with Atlantic Signal PTT and headset</li> </ul>	<b>Weight:</b> <b>Length:</b> <b>Connectors:</b>	TW-860 TSM Spirit
	<b>TW-1688 Audio Adapter, HAP to Invisio PTT</b>	<ul style="list-style-type: none"> <li>Provide audio capability with 2 Talk Groups when used with Invisio PTT and headset</li> </ul>	<b>Weight:</b> 1.4 oz <b>Length:</b> 31.50" <b>Connector 1:</b> CC01 <b>Connector 2:</b> 9-Pin Raymo	TW-860 TSM Spirit

TSM Accessories				
Accessory	Catalog Number/Name	Description	Specifications	Compatible Radio
<b>Audio/Data Adapters</b>				
	<b>TW-2300 USB-A WiFi Adapter</b>	<ul style="list-style-type: none"> <li>Complies with draft IEEE 802.11g standard</li> <li>Features a hardware WPS (Wi-Fi Protected Setup) button for easy wireless connections</li> </ul>	<p><b>Weight:</b> 0.11 oz</p> <p><b>Length:</b> 0.61" x 2.60" x 0.90"</p> <p><b>Connectors:</b> USB-A</p>	TW-860 TSM Spirit
	<b>TW-2301 USB-A Ethernet Adapter</b>	<ul style="list-style-type: none"> <li>Connects your laptop to a TSM Spirit radio</li> <li>Supports true 10/100/1000 Mbps Ethernet network speeds for fast downloads</li> </ul>	<p><b>Weight:</b> 0.96 oz</p> <p><b>Length:</b> 1.57" x 0.62" x 0.27"</p> <p><b>Connectors:</b> USB 3.0 A (Male) and RJ45 (Female)</p>	TW-860 TSM Spirit
<b>Miscellaneous Gear</b>				
	<b>TW-1505 Radio pouch</b>	<ul style="list-style-type: none"> <li>Easily attaches to MOLLE-webbed vests, rucksacks, belts, or packs</li> <li>Extremely durable, lightweight all-weather storage for TW-950/900 radios</li> <li>Side adapter remains accessible for connecting to radio interfaces</li> <li>Radio securely straps in with elastic buckles</li> </ul>	<p><b>Weight:</b> 2.50 oz</p> <p><b>Length:</b> 7.31" x 2.81" x 1.00"</p>	TW-900/950 TSM Shadow
	<b>TW-1521 MOLLE Clip</b>	<ul style="list-style-type: none"> <li>Easily and securely attaches to MOLLE-webbed vests, rucksacks, belts, or packs</li> <li>Clip screws directly into the TSM Spirit radio</li> <li>Low profile clip allows access to all radio connectors and HMI</li> </ul>	<p><b>Weight:</b> 0.08 oz</p> <p><b>Length:</b> 3.19" x 1.28"</p>	TW-860 TSM Spirit











**TrellisWare**  
TECHNOLOGIES

*When Nothing Else Works*

For a complete set of documents, tips,  
tricks and helpful hints, visit the  
TrellisWare Customer Support Center at:  
**[support.trellisware.com](https://support.trellisware.com)**

TrellisWare, the TrellisWare logo, and TSM, TSM Spirit, TSM Shadow, TSM Ghost, CheetahNet, Barrage Relay, When Nothing Else Works, and Trellis//Sphere, are trademarks or registered trademarks of TrellisWare Technologies, Inc. in the United States and other countries. All other trademarks contained herein are the property of their respective owners and their use herein does not imply sponsorship or endorsement of their products or services.

Android™ is a trademark of Google Inc.  
Copyright © August/2022 TrellisWare Technologies, Inc. All Rights Reserved

THE APPEARANCE OF U.S. DEPARTMENT OF DEFENSE (DOD) VISUAL INFORMATION DOES NOT IMPLY OR CONSTITUTE DOD ENDORSEMENT.

J O I N   T H E    \_\_\_\_\_  
T R E L L I S // S P H E R E

10641 Scripps Summit Court, Suite 100, San Diego, CA 92131

Tel: 858.753.1600 | Fax: 858.753.1640

[www.trellisware.com](https://www.trellisware.com)

PC-0001r39